

CLEAR S

USER MANUAL

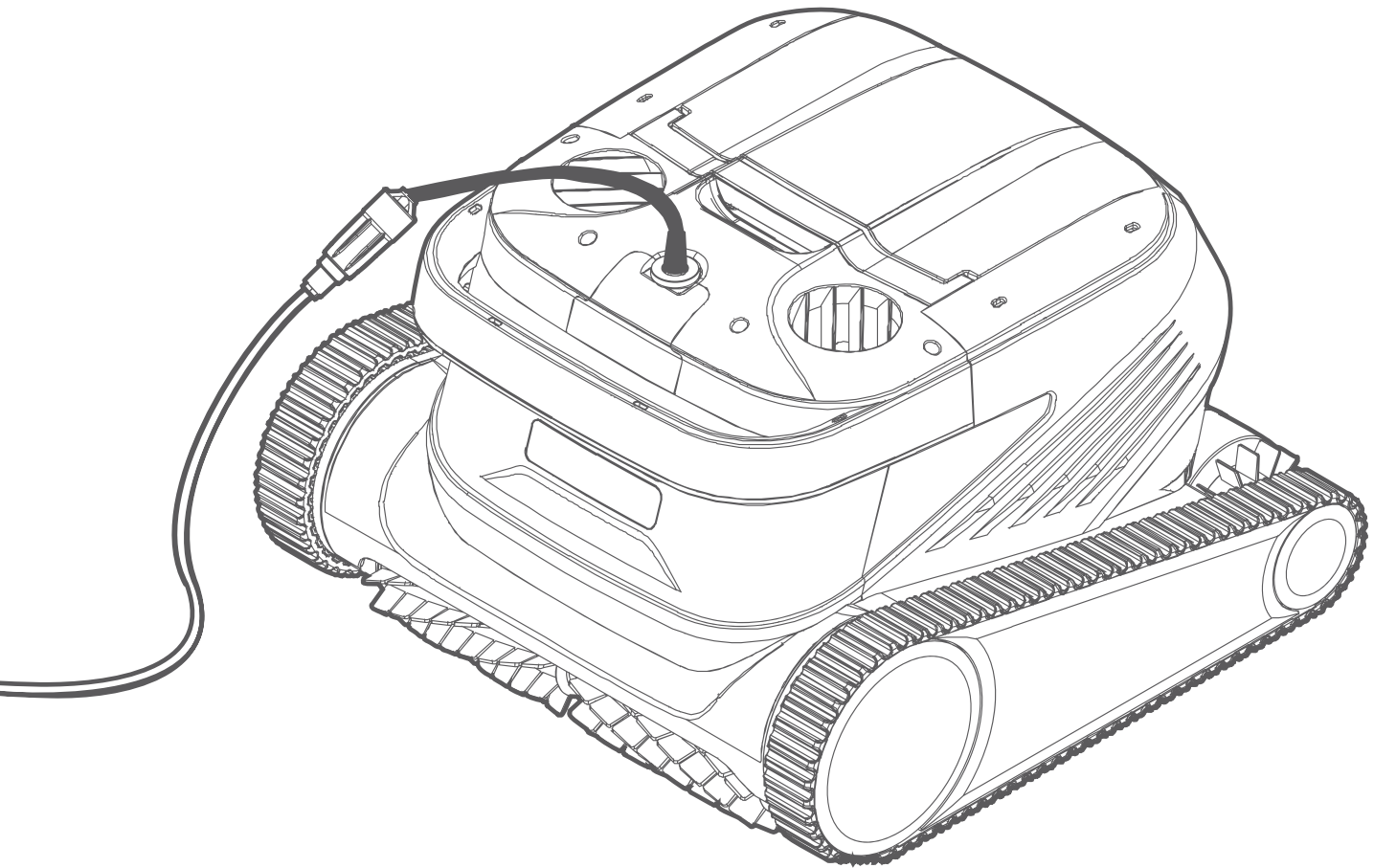

Quick Start Guide

Follow these steps to start cleaning in minutes.

1. Setup

Place the Control Box on a table or stable surface at least **10 ft (3 m)** away from the pool edge. **Ensure it is in a dry, shaded area.**

Important: Ensure no swimmers are in the pool before starting the robot.

2. Connect

Fully uncoil the cable to remove any kinks. Connect the cable to the **RIGHT** port on the **Power Supply (Control Box)** and tighten the nut hand-tight. Connect the **Power Cord** to the **LEFT** port and plug into a **GFCI-protected** outlet.

3. Submerge

Hold the cleaner by the handle and lower it vertically into the pool. Hold it underwater until all air bubbles stop releasing and it sinks to the floor.

Important: The cleaner will not start if trapped air makes it float.

4. Start

Press the **START/STOP** button on the **Power Supply (Control Box)**. The light will turn Green, and the cleaner will begin its cycle.

5. Retrieve

When the cycle ends, press the **Pick-Up button** (on the **Power Supply** or **Smartphone App**). The cleaner will climb to the waterline. **Lift it out by the handle.**

Important: Never lift the robot out of the water by the cable.

6. Clean

Unplug the **Power Supply (Control Box)**. Remove the filter basket and **rinse it with a hose when the basket is full or if suction decreases.**

Tip: For best performance, rinse the basket frequently—even if it doesn't appear full. Fine debris such as silt, pollen, and dust can clog the filter and reduce suction without being visible.

TABLE OF CONTENTS

Quick Setup & Care Guide	05
Product Overview	07
Safety & Precautions	09
Connection & Operation	11
Power Supply (Control Box) Functions	13
Smartphone App & Remote Control	18
Maintenance	21
Troubleshooting	23
Specifications	25



Please read this manual carefully before use. Operation of this product signifies acceptance of these terms. Clear S is not liable for injury or damage resulting from:

Improper use, assembly, or operation not in accordance with this manual.

Use by children or unauthorized persons.

Use of non-original parts or accessories.

Electrical issues caused by improper power sources.

Getting the Most From Your Pool Robot

Welcome! You've just saved yourself hundreds of hours of manual pool cleaning. This guide will help you get up and running smoothly—most owners are enjoying a sparkling pool within 15 minutes.

Good to know: The occasional hiccup during setup is completely normal. The solutions below work for 9 out of 10 owners, usually in just a few minutes.

First-Time Setup Checklist

Before your robot's first swim, a few quick steps will ensure the best performance right away.

- 1. Prep the cable.** Uncoil the full length, lay it flat, and gently work out any twists. This simple step prevents most tangling issues down the road.
- 2. Position the Power Supply.** Place the Power Supply roughly centered along the long side of the pool. In a shaded spot on dry ground, at least 10 feet from the water's edge. Good airflow underneath helps it run cool and quiet.
- 3. Remove the air.** Hold the robot vertically in the water and rotate it slowly until all bubbles escape. Once it sinks on its own, you're ready to power on.

Quick tip: Always submerge fully before turning on—this protects the motor and ensures proper movement.

Understanding Your Robot's Movements

Your robot may pause, reverse, repeat sections, or change direction randomly. It might climb a wall and slide back down before trying again.

This is normal behavior and part of the robot's navigation system. Most owners notice it becomes more efficient after a few cycles.

If the Outlet Trips

In most cases this is not caused by the robot. It is usually the outlet, circuit, or moisture in the outlet. Here's a simple way to find out:

Test the outlet first. Plug in a lamp or phone charger. If it doesn't power on, the outlet itself may need attention.

1. **Test the power supply alone.** Disconnect the robot cable and plug in just the power supply. Lights on? Great—move to the next step.
2. **Reconnect and submerge.** Reattach the cable, place the robot fully underwater, then power on.

If the outlet trips again after these steps, reach out to us—we'll sort it out together.

Helpful notes:

Outdoor outlets can collect moisture, especially after rain.

- Outdoor outlets with GFCI protectors must be replaced periodically. Outdoor outlets with GFCI may only last 5-7 years due to heat and humidity.
- If other high-draw appliances share the circuit, try a different outlet.
- We recommend plugging directly into the outlet (extension cords can cause interference).

Getting the Best Results in Your Pool

Water clarity matters. If you cannot clearly see the main drain at the bottom of the pool, improve water clarity before using the robot. A quick shock, brush-down, and debris skim will help your robot perform at its best—and keep the filters from working overtime.

Vinyl liner pools work beautifully with this robot when the liner is snug. If your liner has wrinkles or loose areas, we recommend addressing them first to protect both the liner and the robot.

Simple Maintenance Habits

These small habits keep everything running smoothly for years:

- **Cable care:** When not in use, coil loosely and store out of direct sun.
Tight coiling can create memory twists.
- **Filter check:** A quick rinse keeps suction strong.

Clear S: Intelligent Pool Cleaning

The Clear S automatic pool cleaner is designed to effortlessly clean your pool's floor, walls, and waterline. Featuring UltraFilter, it scrubs and vacuums debris, ensuring a cleaner, healthier pool

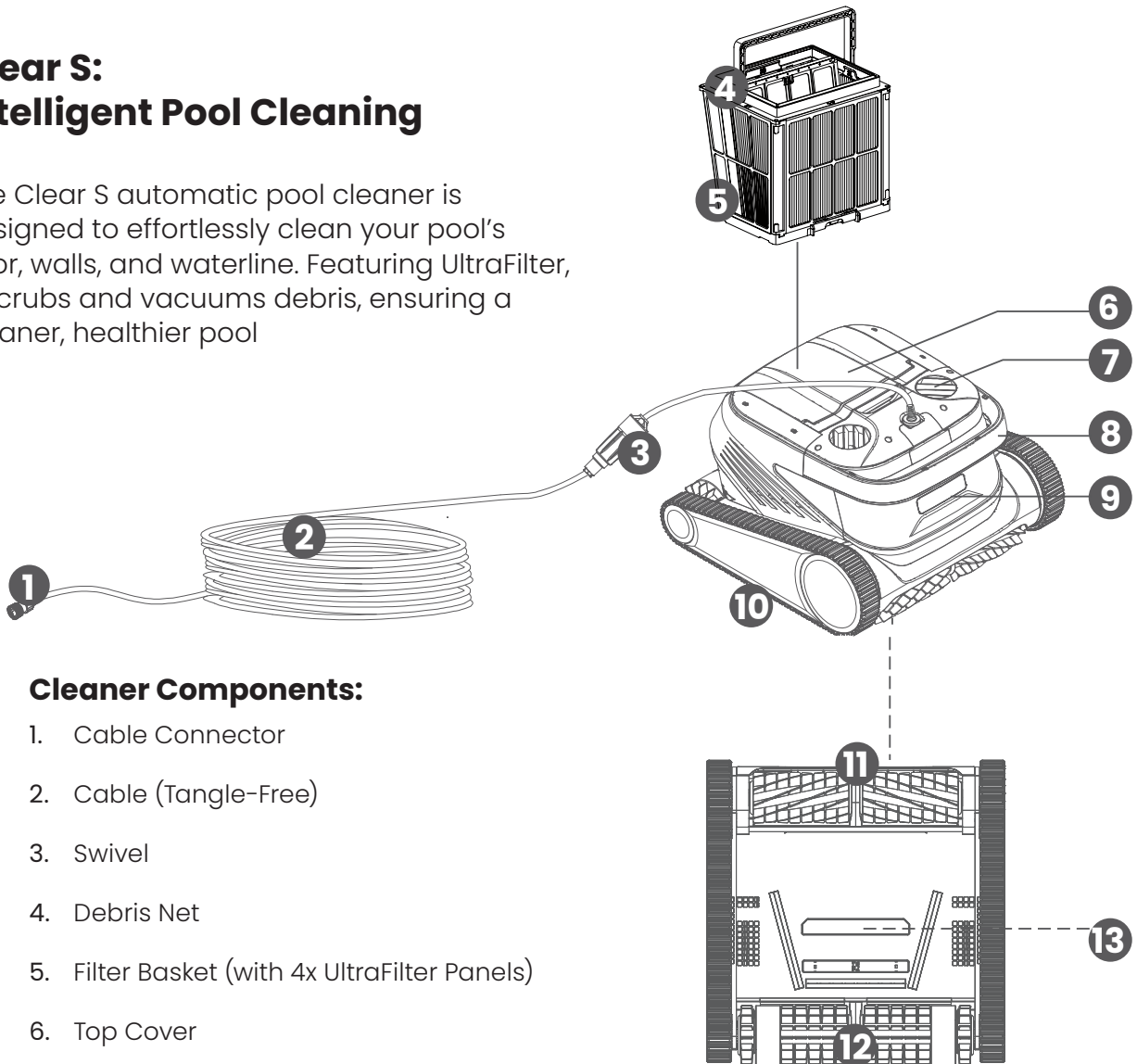

Cleaner Components:

1. Cable Connector
2. Cable (Tangle-Free)
3. Swivel
4. Debris Net
5. Filter Basket (with 4x UltraFilter Panels)
6. Top Cover
7. Impeller
8. Handle
9. LED Status Light
10. Drive Tracks
11. Active Scrubbing Brush
12. Rear Brush
13. Water Inlet

Power Supply (Control Box)

1. Power plug
2. Power cord
3. Display & operation panel
4. Cable port

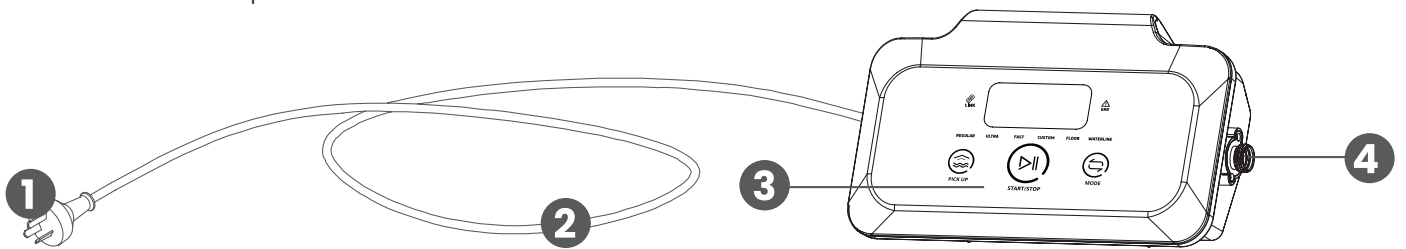

UltraFilter Panels 2 Sets (1 Preinstalled in UltraBin)

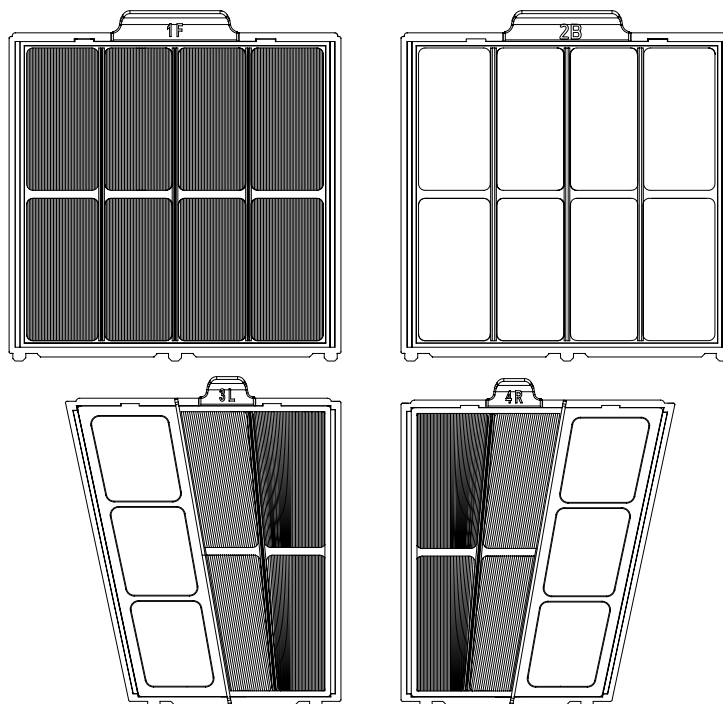



READ CAREFULLY BEFORE USE

Failure to follow these instructions may result in injury or damage. The manufacturer assumes no liability for loss or injury caused by improper use.

WARNING

! WARNING (Severe Injury Risk)



- **Electrical Shock Hazard:** Connect the Power Supply (Control Box) ONLY to a supply circuit protected by a Ground Fault Circuit Interrupter (GFCI). Test the GFCI before each use to ensure it is working.



- **Crush Hazard:** Do not touch the rotating tracks, brushes, or impellers while the cleaner is operating.



- **Cable Safety: NEVER** lift or pull the cleaner by the Cable. Always use the handle. Pulling the cable too hard can damage internal wires and is not covered by warranty.



- **Do Not Swim:** Never enter the pool while the cleaner is in the water.



- **Keep Children Away:** Do not allow children to operate the cleaner or play near the Power Supply (Control Box) without direct adult supervision.



- **No Modifications:** Do not attempt to disassemble or repair the cleaner or Power Supply (Control Box). There are no user-serviceable parts inside. Unauthorized repairs will void the warranty and **may cause an electrical hazard.**



NOTICE

! NOTICE (Equipment Protection)

- **Control Box Positioning:** The Control Box is water-resistant (IP54) but not waterproof.
- **Keep it at least 10 ft (3 m)** from the pool edge.
- **Keep it at least 4 in (10cm)** off the ground.
- **Do not expose to direct sunlight:** Overheating will trigger the thermal protection sensor and shut down the unit to prevent damage.



CAUTION

CAUTION: To avoid injury, do not touch internal rotating components while the cleaner is powered on.

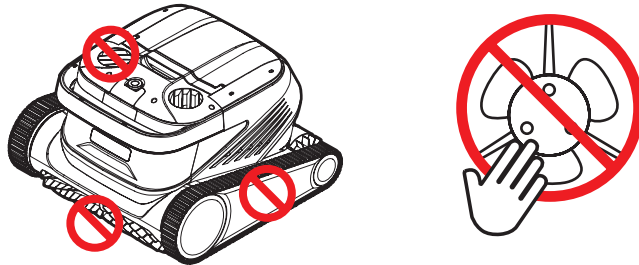

CAUTION

CAUTION: Always use the built-in handle to lower or lift the cleaner. **Never use the cable to apply force to the robot**, as this may damage the internal connections. Only use the cable to gently guide or manage slack.



IMPORTANT

IMPORTANT: Do not operate the cleaner immediately after adding liquid flocculants or water clarifiers. These chemicals can clog or permanently damage the filtration components. Ensure the water is clear before resuming use.

OPERATING SPECIFICATIONS: To ensure peak performance and longevity, only operate the cleaner within the following parameters:

Working Depth	2.5–16.4 ft (0.8–5 m)	Operating temperature	50–95 °F
pH	7.0–7.8	Salt	Maximum 5000 ppm
Free Chlorine	Maximum 4 ppm		



NOTICE

Notice: Avoid using your cleaner in extreme heat or leaving the Power Supply (Control Box) in intense, direct sunlight for long periods. The unit may shut down automatically to protect its electronics. Operating outside of the specified temperature range may result in permanent damage.

1. Setup

1.1. Place the Control Box on a stable, dry surface at least 10 ft (3 m) from the pool.

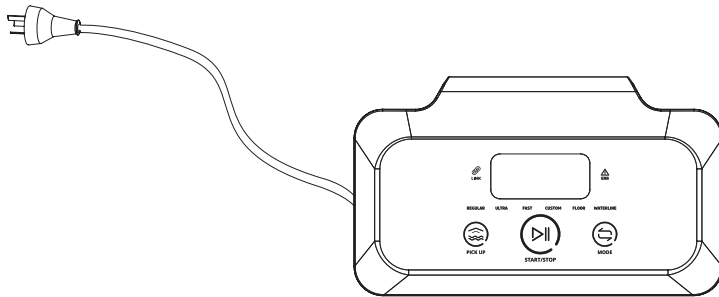

1.2. Uncoil the Cable completely to remove any twists

1.3. Insert the Cable into the RIGHT port on the Control Box and tighten the nut

1.4. Insert the Power Cord into the LEFT port and plug into the power outlet. The START/STOP button will glow Yellow (Standby)

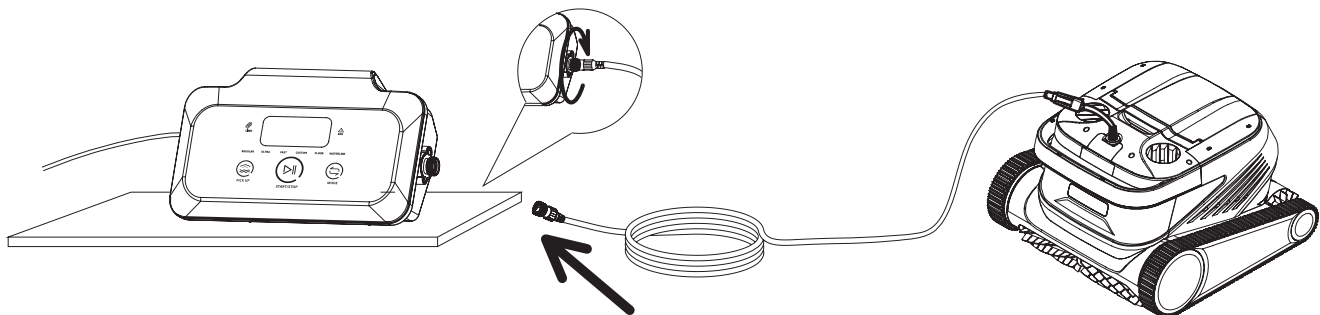

2. Placement

2.1. Hold the cleaner by the handle and submerge it slowly

2.2. Tilt the cleaner side-to-side underwater to release trapped air. Wait until no more bubbles appear.

2.3. Let the cleaner sink to the pool floor.

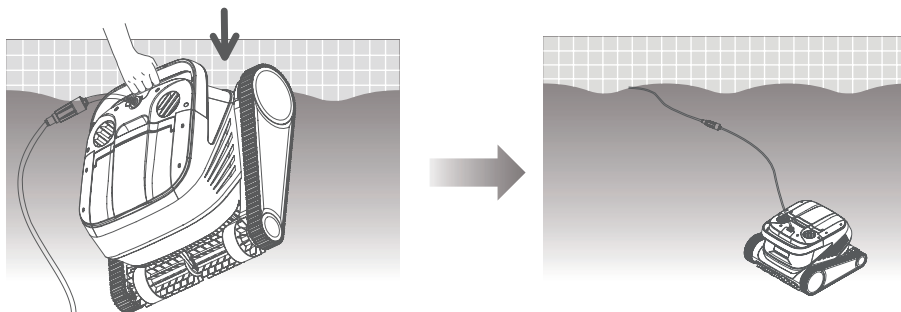

Notice: Place the Cable so it lies freely on the water surface. Do not leave it coiled, twisted, or under tension. If the cable is too short or tight, the cleaner may tilt, lose balance, or fail to clean all areas of the pool or result in permanent damage.



- 2.4. ① Plug the power cord into the Power Supply (Control Box) and plug it into a wall outlet (AC 100 - 120 V).
- ② The **START/STOP** button on the Power Supply (Control Box) will turn **yellow**, indicating that the cleaner is in **standby mode**.

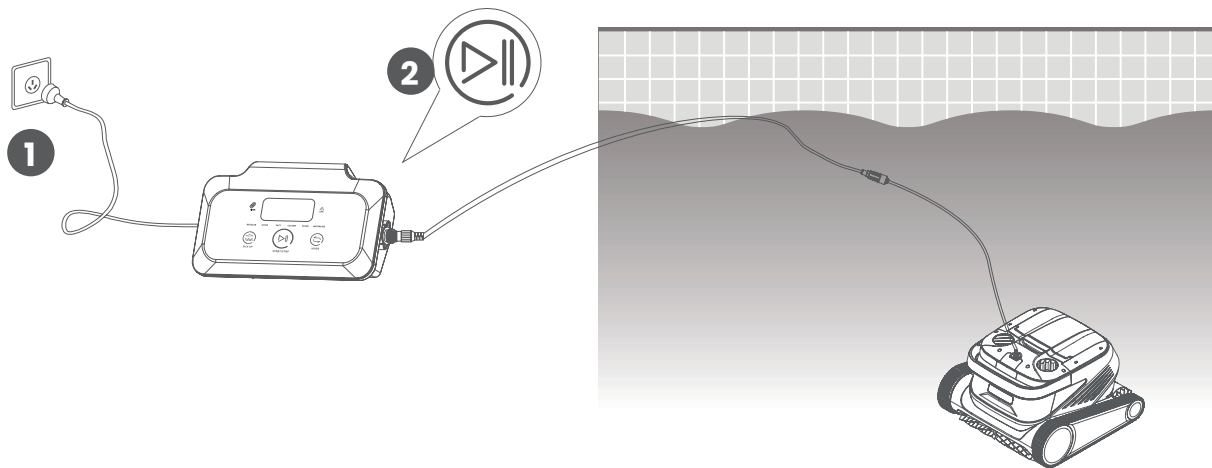

3. Power Supply (Control Box) Functions

3.1. Sleep Mode

If the Power Supply (Control Box) is not used for 3 minutes, the indicator lights will enter **sleep mode** and only the **ON/OFF button will remain illuminated**.

Press any button to wake the indicator lights. **The first press will wake the lights only and will not activate the selected function.**

3.2. How to Quick Start

1. Press to cycle through cleaning programs (Floor, Waterline, etc.).
2. Short Press: **Start/Pause**.



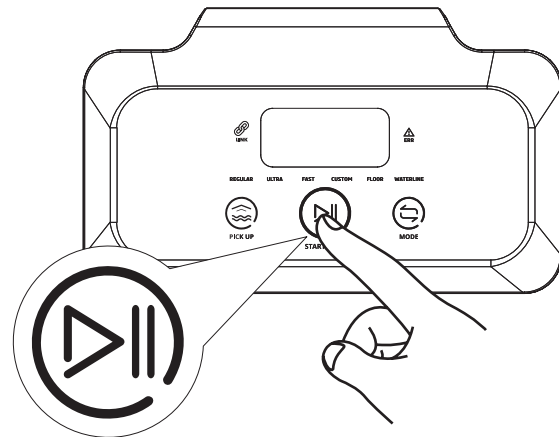

3.3. Stop

Long Press: **Stop**



Start/Pause

Basic cleaning functions can be operated directly from the **Power Supply** (Control Box). For additional features and advanced settings like the **Weekly Timer** and more, use the **Smartphone App**.

	Symbol	Description	Indicator Behavior
Button	 START / STOP	Short Press: Start or pause cleaning Long Press: Stop cleaning	Yellow Light On: Cleaning stopped Green Light Flashing: Cleaning paused Green Light Steady: Cleaning started Blue Light Steady: Cleaning started Red Light Steady: Power Supply (Control Box) fault Red Light Flashing: Cleaner fault detected
	 Pick-Up Mode	Short Press: Activate pick-up mode for easy removal from the pool	Indicator light turns on when pick-up mode is active
	 Mode Selection	Short Press: Switch between cleaning modes (custom mode) must be configured in the smartphone app)	Indicator light turns on when the unit is powered on
Indicator Light	 Link / Wi-Fi Status	Indicates connection status between the power supply (control box) and Wi-Fi	Light flashes while a mobile device connects to the control box. The light stays on once the app detects the cleaner.
	 Error Indicator	Indicates a system fault in the cleaner or power supply (control box)	Indicator light flashes when a fault is detected
Modes		Description	
Cleaning Modes	REGULAR (Standard Mode)	2-hour cleaning cycle covering pool floor, walls, and waterline. The corresponding mode indicator lights when selected.	
	ULTRA (Enhanced Mode)	3-hour cleaning cycle covering pool floor, walls, and waterline.	
	FAST (Quick Mode)	1-hour cleaning cycle covering pool floor, walls, and waterline.	
	CUSTOM (Custom Mode)	Cleaning settings are configured through the smartphone app.	
	FLOOR Mode	2-hour cycle cleaning the pool floor only.	
	WATERLINE Mode	2-hour cycle cleaning pool walls and the waterline.	

	Display	Description
Display Information	88:88 Cleaning Countdown	Displays the remaining cleaning time during operation

	Error Code	Description
Error Codes	E:00	Communication fault between the control box and the cleaner
	E:01	Power supply voltage fault
	E:02	Accelerometer fault
	E:03	Gyroscope fault
	E:15	Left drive motor fault or impeller jam
	E:25	Right drive motor fault or impeller jam
	E:35	Drive motor system fault (multiple motors or impeller jam)
	E:16	Left pump motor fault or impeller jam
	E:26	Right pump motor fault or impeller jam
	E:36	Pump motor system fault (multiple motors or impeller jam)

Sleep Mode

If the Power Supply (Control Box) is not used for 3 minutes, the indicator lights will enter **sleep mode** and only the **ON/OFF button will remain illuminated**.

Press any button to wake the indicator lights. **The first press will wake the lights only and will not activate the selected function.**

3.4. Indicator Light of the Cleaner

Light status	Description
White light on	System self-check in progress
Yellow light on	Standby mode (cleaner is in the water)
Orange light on (solid)	Cleaner is not in the water
Green light flashing	Cleaning paused
Green light spinning	Cleaning cycle active
Blue light spinning	Cleaning cycle active
Yellow light spinning	Motor may be blocked
Red light flashing	Cleaner error detected
Cyan light spinning	Filter may be clogged

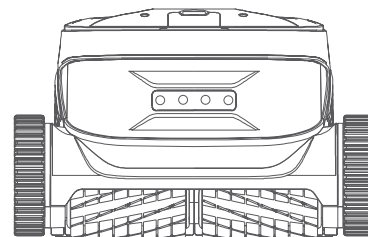

4. Pick-Up Mode

4.1. Method 1:

1. Tap any button once to wake the robot out of sleep mode, then tap "Pick-Up" button on the **Power Supply (Control Box)**.

Power Supply (Control Box)

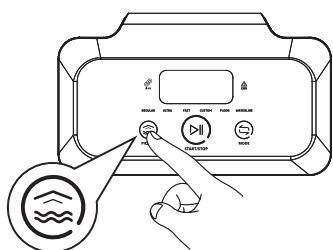

Smartphone App

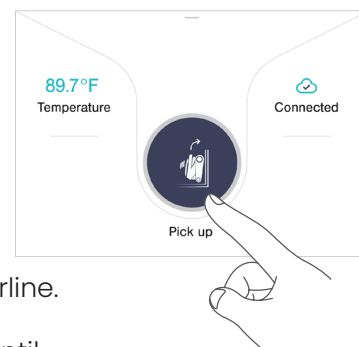

2. The cleaner will drive to the nearest wall and climb to the waterline.
3. Wait for it to hold position, then lift it out by the handle.

TIP: To reduce weight before lifting, hold above the waterline until the water drains.

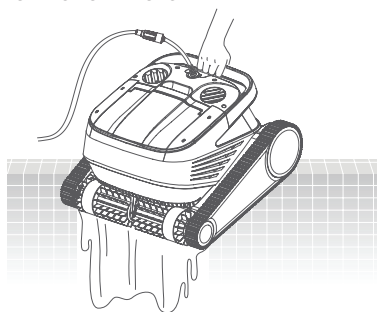
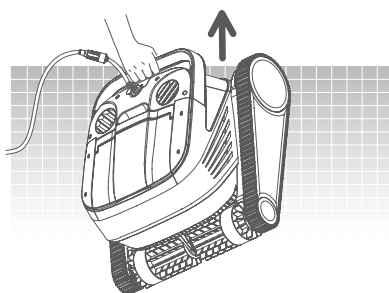

4.2. Method 2:

1. Gently pull the cable to guide the cleaner toward the pool wall. **Do not lift it out of the water by the cable.**

Important: Never lift the robot out of the water by the cable. **Only use the cable to gently pull the robot to the side of the pool.**

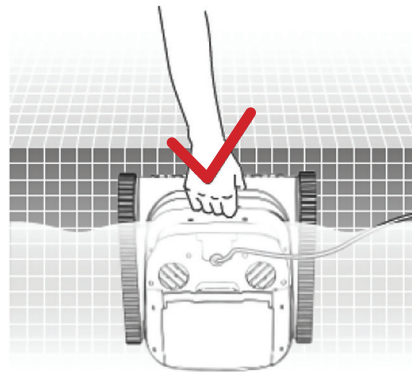
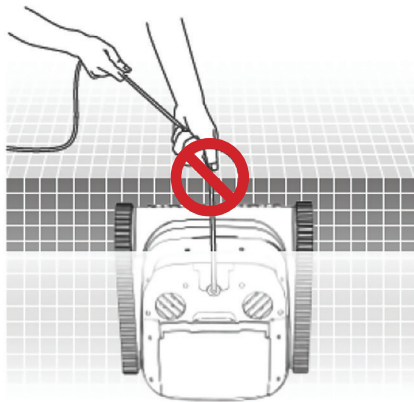

2. Grasp the cleaner by its handle and lift it out of the water.

TIP: Hold it above the water for 10–20 seconds to allow the water inside to drain completely.

1 Download Clear S App

Search for "**Clear S**" in the Apple App Store or Google Play, visit ClearRobot.com/app or **scan the QR code**.



2 Bluetooth Connection

1. Enable Bluetooth and Wi-Fi on your phone.

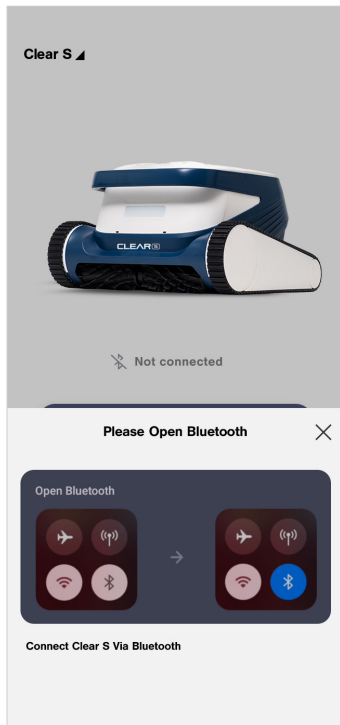

2. Open the Clear S app and select your model.



3 Smartphone App

1. Press "To Connect"

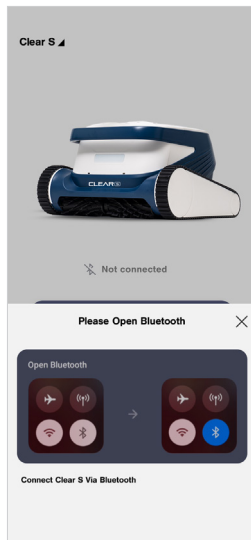

2. Your phone will search for your robot

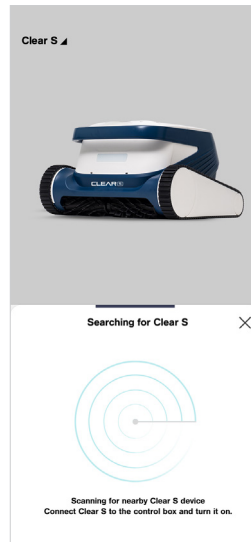

3. Your robot is connected

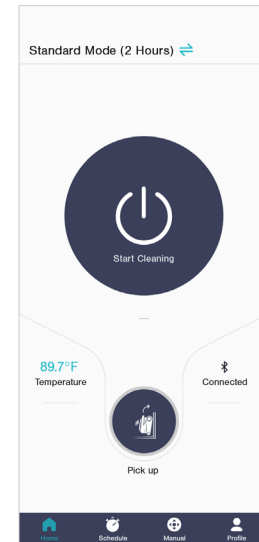

4 Remote Control

1. Tap "**Remote Control**" on the **Smartphone App** home screen.
2. Use the virtual joystick to steer the cleaner to specific areas of the pool.

Important: You must create and log in to a Clear S account to use the Remote Control feature.

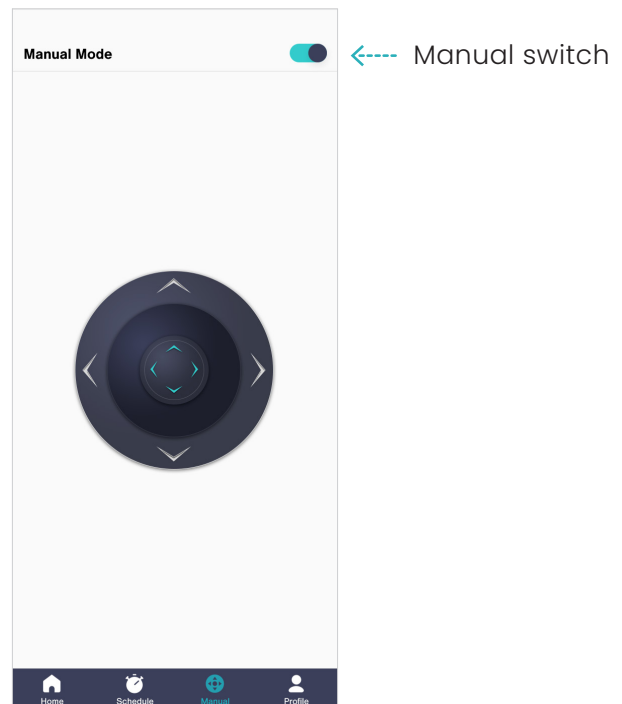

Weekly Timer Scheduled Cleaning

You can set the cleaner to run automatically if it is left in the pool (e.g., weekly scheduler).

1. In the **Smartphone App**, select **Timer/Delay**.
2. Choose **"Timed Cleaning"** to set a recurring schedule.
3. Select the desired cleaning mode and save.

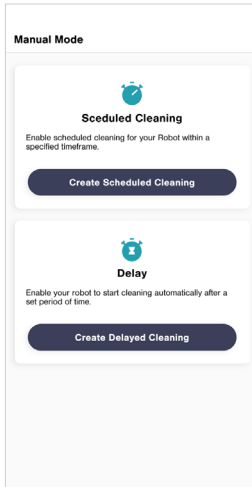

Pick between Scheduled Cleaning or Delayed Cleaning

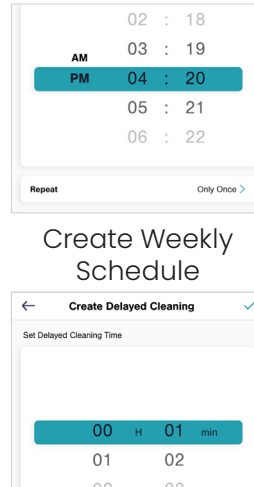

Create Cleaning Delay

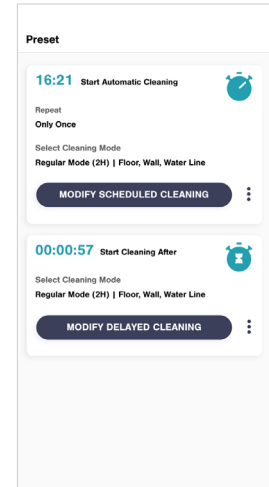

Your Presets Will Show Here

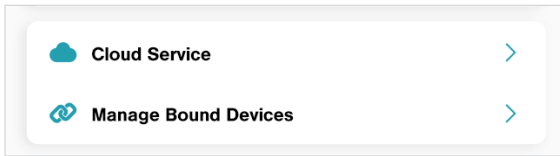

***Important:** You can unbind the robot and add new robots via **"Manage Bound Devices"**. If you cannot unbind the robot, please contact the Clear S (ClearRobot.com/support) service department.

Home

- Mode switching
- Start cleaning
- Connection status of the power supply
- Water temperature



Select Cleaning Mode

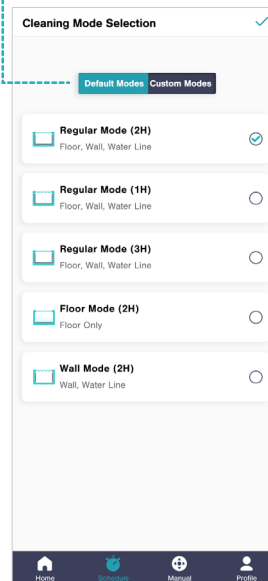

Custom Mode

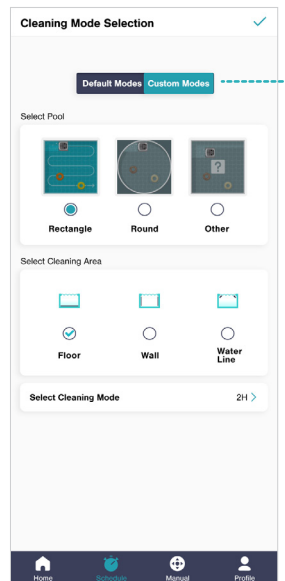

1 Clean the filter basket

1.1. Remove the Filter Basket from the robot.

1. Unplug the Power Supply (Control Box).
2. Open the top cover
3. Lift out the Filter Basket.
4. Use a garden hose to rinse the debris from the basket and the filter panels.

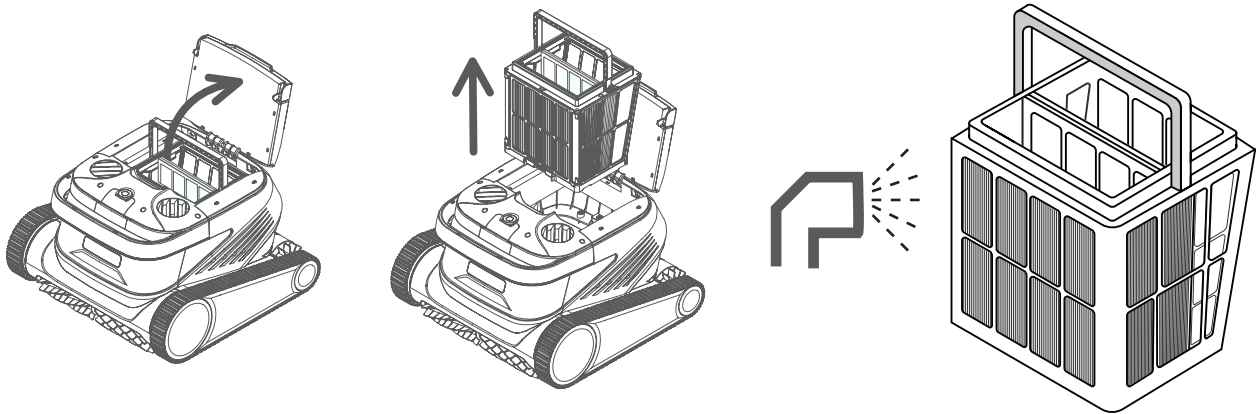

2 Replacing the Filter Panels

2.1. To Remove: Press gently on the basket frame and slide the panels UP and OUT in this order: Middle (5M) → Front (1) → Back (2) → Left (3) → Right (4).

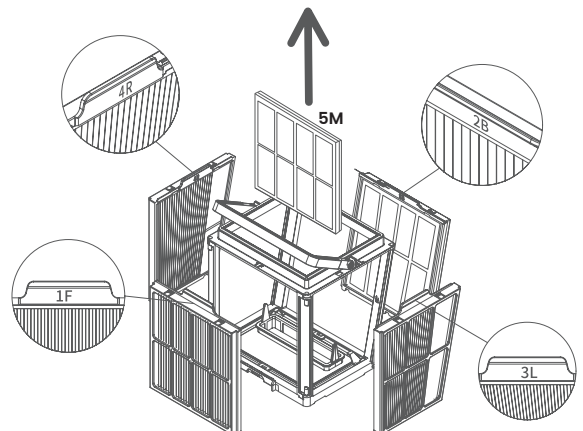

2.2. To Install: Slide new panels IN using the reverse order:
Right (4) → Left (3) → Back (2) → Front (1) → Middle (5M)

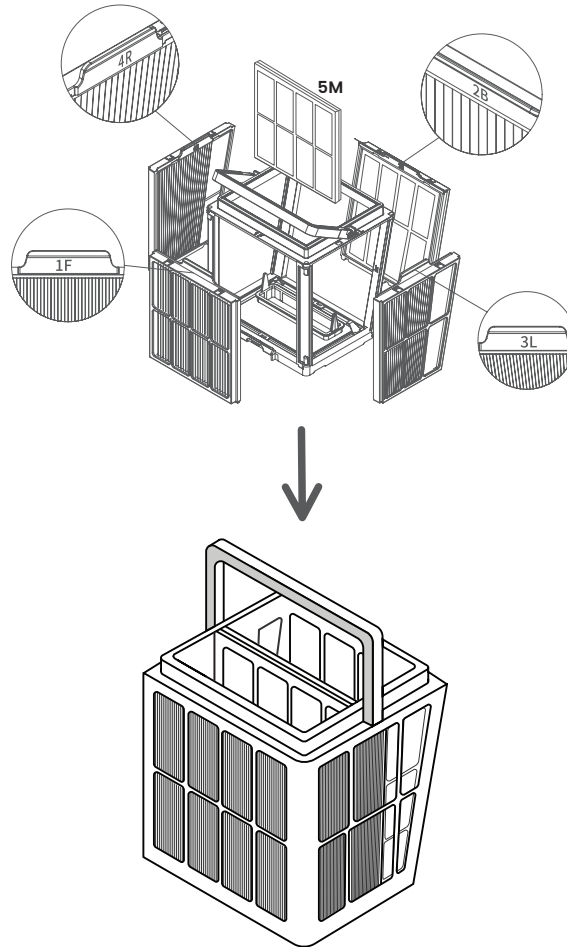

Important: The UltraFilter is designed to capture very small particles and fine debris for enhanced water clarity. It should be handled with care. To maintain optimal cleaning performance, we recommend replacing the UltraFilter every 3-6 months depending on pool conditions.

3 Storage

If the cleaner will not be used for an extended period, please follow the steps below:

1. Clean and dry the filter basket and cleaner.
2. Coil the cable loosely (**do not wrap tight**).
Store in a dry, shaded place between 40 and 100°F.

Tutorial videos and troubleshooting guides are available at:
www.ClearRobot.com/support

Symptom	Cause	Solution
Cable becomes tangled	Cable not fully extended	Disconnect the power supply (control box) and straighten the cable before restarting
	Obstacles in the pool	Remove any obstacles from the pool
	Extended cleaning cycle caused Cable Twisting	Untangle the cable and lay it on flat ground in the sun for 8 hours
Cleaner does not start	No power from wall outlet	Verify the wall outlet has power
	Power cord not fully plugged in	Firmly plug the power cord into the outlet
	Cable connection loose	Check that both ends of the cable are securely connected
	Track jammed with debris	Inspect the tracks and remove any debris
	Track has come off drive wheel	Reinstall the track onto the drive wheels
	Cleaner not submerged in water	Place the cleaner fully into the pool
	Electrical fault in cleaner or power supply (control box)	Check the error code and contact authorized service
Cleaner moves but does not clean effectively	Filter basket clogged	Clean the filter basket, Replace filters as necessary
	Pump impellers blocked by debris	Inspect the impellers and remove any debris

Tutorial videos and troubleshooting guides are available at:
www.ClearRobot.com/support

Symptom	Cause	Solution
Cleaner cannot climb walls	Filter basket clogged	Clean the filter basket, Replace filters as necessary
	Pump impellers blocked by debris	Inspect the impellers and remove any debris
	Pool water temperature or pH outside operating range	Operate the cleaner only within recommended water temperature and pH levels
	Algae buildup on pool walls	Test and balance pool chemistry, then brush the pool walls
Cleaner only cleans part of the pool	Power supply (control box) positioned incorrectly	Place the power supply (control box) in a location that allows the cleaner to reach all areas of the pool
	Cable not fully extended	Disconnect the power supply (control box) and straighten the cable
	Filter basket clogged	Clean the filter basket, Replace filters as necessary
	Obstacles in the pool	Remove any obstacles from the pool
	Cleaner gets stuck on drain	Contact customer support for drain attachment



Cleaner Stuck on Drain.

Important: If your robot becomes stuck on the pool's main drain, contact customer support to obtain a drain attachment.

Dimension of cleaner	19.1 × 18.7 × 13.5 in	Movement speed	15 m/min
Weight of cleaner	27.6 lb (without cable)	Ingress Protection of cleaner	IP68
Dimension of power supply	13.9 × 3.2 × 8.3 in	Ingress Protection of power supply	IP54
Weight of power supply	5.1 lb (without cable)	Anti-tangle cable	Yes
Filter precision	1µm/180µm	Active brushes	2
Cable length	59 ft	Pump motors	2
Rated input voltage	AC 100 - 120 V; 50-60Hz	Drive motors	2
Rated working voltage	DC 24 V	Smartphone app	Yes
Power	Avg. input power: 250 W Max. input power: 320 W	Weekly Timer	Yes
Minimum water depth	2.5 - 16.4 ft	Manual mode	Yes
Maximum pool length	Up to 50 ft	Water temperature display	Yes
Cleaning area	Floors, Walls, & Waterline	Operating temperature	50 - 95°F
UV Disinfection	No	Storage temperature	41 - 113°F
		Cloud service	Yes

Contact Support

For technical questions or warranty service, please contact your regional support team:
www.ClearRobot.com/support

Website: **www.ClearRobot.com**

Phone: (737) 327-3005

Tutorial videos and troubleshooting are available at **ClearRobot.com**

Clear S

This guide may be updated without notice.

Visit the official Clear S website for the latest version: **ClearRobot.com**

CLEAR 

ClearRobot.com